



PHILIPS  
RESPIRONICS

DreamStation

BiPAP autoSV



REF 1128728



Respironics Inc.  
1001 Murry Ridge Lane  
Murrysville, PA 15668 USA

Respironics Deutschland GmbH & Co. KG  
Gewerbestr. 17  
82211 Herrsching, Germany



EC REP

1128728 R10  
HM 06/13/2017  
EN-INTL

User manual

# Table of contents

<b>1. Introduction</b>	<b>1</b>
1.1 Package contents	1
1.2 Intended use	1
1.3 Safety information	2
1.4 Symbol key	8
1.5 System overview	9
1.6 How to contact Philips Respironics	12
<b>2. Device setup</b>	<b>13</b>
2.1 Installing and replacing the air filters	13
2.2 Positioning the device	14
2.3 Supplying AC power to the device	15
2.4 Connecting the breathing circuit	16
2.5 Starting the device	17
2.6 Navigating the device screens	18
2.7 Therapy screen features and optional humidification settings	19
2.8 Patient menu navigation	21
2.9 Connecting to Wi-Fi (if available)	26
2.10 <i>Bluetooth</i> <sup>®</sup> wireless technology*	27
2.11 Check mask fit	29
2.12 Sleep progress	29
2.13 Altitude compensation	30
<b>3. Alarms, alerts, and troubleshooting</b>	<b>31</b>
3.1 Device alarms	31
3.2 Device alerts	31
3.3 Alarm and alert LED indicators	31
3.4 Alarm and alert audible indicators	32
3.5 Silencing an alarm	32
3.6 Alarm message screens	33
3.7 What to do when an alarm occurs	33
3.8 Alarm summary table	34
3.9 Alert summary table	37
3.10 Troubleshooting	41
<b>4. Accessories</b>	<b>45</b>
4.1 Humidifier	45
4.2 SD card	45
4.3 Cellular modem	45
4.4 Wi-Fi accessory	45
4.5 Link module	46

4.6	Oximeter.....	46
4.7	Philips Respironics proprietary compliance software.....	46
4.8	Roll stand.....	46
4.9	Supplemental oxygen.....	47
4.10	DC power cord.....	47
4.11	Carrying case and airline travel.....	48
<b>5.</b>	<b>Care, cleaning, and disinfection.....</b>	<b>49</b>
5.1	Caring for the filters.....	49
5.2	Home cleaning: device and humidifier.....	50
5.3	Home cleaning: tubing.....	50
5.4	Hospital and institution cleaning: device and humidifier exterior.....	50
5.5	Hospital and institution disinfection: device and humidifier exterior.....	51
5.6	Service.....	52
<b>6.</b>	<b>Specifications, disposal, and EMC.....</b>	<b>53</b>
6.1	Specifications.....	53
6.2	Disposal.....	56
6.3	EMC information.....	56
	<b>Limited warranty.....</b>	<b>59</b>

# 1. Introduction

This chapter provides an overview of the DreamStation BiPAP autoSV device. Take time to read the entire manual before using your device for the first time. This chapter includes:

- Package contents
- Intended use
- Safety information
- System overview

## 1.1 Package contents

Your DreamStation system may include the following components. Some components are optional accessories that may not be packaged with the device.

- Device
- User manual
- Carrying case
- Power cord
- Power supply
- SD card
- Flexible tubing
- Reusable blue pollen filter
- Disposable light-blue ultra-fine filter (optional)
- Humidifier (optional)

## 1.2 Intended use

The device is intended to provide mask-applied non-invasive ventilatory support to adult patients (>30 kg) for the primary treatment of obstructive sleep-disordered breathing with secondary Central Sleep Apnea or Cheyne-Stokes Respiration (CSR). The device may be used in the hospital or home.

## 1.3 Safety information

### 1.3.1 Warnings

A warning indicates the possibility of injury to the user or operator.

<b>Device usage</b>	<p>This device is not intended for life support or invasive ventilation. The device provides Positive Pressure Ventilation and is indicated for assisted ventilation through a noninvasive interface. The device has the capability of providing a back-up rate as needed.</p> <p>The device does not provide ventilation with a guaranteed tidal volume delivery. Patients requiring ventilation at a predetermined tidal volume are not candidates for Pressure Support ventilation.</p>
<b>Personnel qualifications</b>	<p>This manual serves as a reference. The instructions in this manual are not intended to supersede your health care professional's instructions regarding the use of the device.</p> <p>The prescription and other device settings should only be changed on the order of the supervising physician.</p> <p>The operator should read and understand this entire manual before using the device.</p>
<b>SD card prescription changes</b>	<p>When making a therapy prescription or alarm setting change with the SD card, the health care professional must review and verify any prescription changes before using the device. The health care professional is responsible to ensure that the prescription settings are correct and compatible with the patient after using this feature. Installing the wrong prescription for a particular patient may result in improper therapy, lack of appropriate safety monitoring, and injury to the patient.</p>
<b>Operating and storage temperatures</b>	<p>Do not use this device if the room temperature is warmer than 95° F (35° C) because the temperature of the airflow may exceed 109° F (43° C). This could cause thermal irritation or injury to the patient's airway.</p> <p>Do not use the device while positioned in a warm place, such as direct sunlight or near a heating appliance. These conditions can increase the temperature of the airflow and could cause thermal irritation or injury to the patient's airway.</p>
<b>Device start-up</b>	<p>Make sure the device is working properly at start-up. Always verify that the alarm LEDs light red then yellow momentarily. Contact Philips Respironics or an authorized service center for service if these indications do not occur at start-up. See Chapter 2 for more information about device start-up.</p>
<b>Bacteria filter</b>	<p>If the device is used by multiple persons in a hospital environment (such as rental devices), a low-resistance, main flow bacteria filter should be installed in-line between the device and the circuit tubing to prevent contamination.</p>

<b>Patient circuits</b>	<p>The ventilator should only be used with compatible patient interfaces (e.g., masks, circuits and exhalation ports). Proper operation of the device, including alarms, with other circuits has not been verified by Philips Respironics and is the responsibility of the health care professional. A mask should not be used unless the device is turned on and operating properly. The exhalation port(s) associated with the mask should never be blocked.</p> <p>Explanation of warning: The device is intended to be used with special masks or connectors that have exhalation ports to allow continuous flow of air out of the mask. When the device is turned on a functioning properly, new air from the device flushes the exhaled air out through the mask exhalation port. However, when the device is not operating, enough fresh air will not be provided through the mask, and exhaled air may be rebreathed. Rebreathing of exhaled air can, in some circumstances, lead to suffocation.</p> <p>If you are using a full face mask (a mask covering both your mouth and your nose), the mask must be equipped with a safety (entrainment) valve.</p> <p>An exhalation port is required. Do not block the exhalation port. This can reduce airflow and result in rebreathing of exhaled air.</p> <p>At low expiratory pressures, the flow through the exhalation port may be inadequate to clear all exhaled gas from the tubing – some rebreathing may occur.</p> <p>Do not pull or stretch the tubing. This could result in circuit leaks.</p> <p>Verify operation of the Patient Disconnect alarm with any changes in the patient circuit.</p>
<b>Improperly functioning ventilator</b>	<p>If you notice any unexplained changes in the performance of the device, if it is making unusual sounds, if water is spilled into the enclosure, or if the enclosure is cracked or broken, discontinue use and contact your home care service provider.</p>
<b>Circuit disconnect</b>	<p>You should not rely on any single alarm to detect a circuit disconnect condition. The Low Minute Ventilation and Apnea alarms should be used in conjunction with the Circuit Disconnect alarm.</p> <p>Test the operation of the circuit disconnect function whenever a change is made to the circuit. An increase in circuit resistance can prevent proper operation of some alarms.</p>
<b>Power cord</b>	<p>Route the power cord to the outlet in a way that will prevent the cord from being tripped over or interfered with by chairs or other furniture.</p> <p>This device is activated when the power cord is connected.</p> <p>Use only power cords supplied by Philips Respironics for this device. Use of power cords not supplied by Philips Respironics may cause overheating or damage to the device.</p>
<b>Accessories</b>	<p>To ensure that you receive safe, effective therapy, use only Philips Respironics accessories. The use of accessories, transducers, and cables other than those specified by Philips Respironics may result in increased emissions or decreased immunity of the device.</p>

<p><b>Oxygen</b></p>	<p>When administering fixed-flow supplemental oxygen, the oxygen concentration may not be constant. The inspired oxygen concentration will vary, depending on the pressures, patient flows and circuit leak. Substantial leaks may reduce the inspired oxygen concentration to less than the expected value. Appropriate patient monitoring should be used, as medically indicated, such as an alarming pulse oximeter.</p> <p>When using oxygen with this system, the oxygen supply must comply with local regulations for medical oxygen.</p> <p>Do not connect the device to an unregulated or high pressure oxygen source.</p> <p>When using oxygen with this system, a Philips Respironics pressure valve must be placed in-line with the patient circuit between the device and the oxygen source. The pressure valve helps to prevent the back flow of oxygen from the patient circuit into the device when the unit is off. Failure to use the pressure valve could result in a fire hazard.</p> <p>Oxygen supports combustion. Oxygen should not be used while smoking or in the presence of an open flame.</p> <p>Do not use the device in the presence of a flammable anaesthetic mixture in combination with oxygen or air, in the presence of nitrous oxide, or in an oxygen-enriched environment.</p> <p>Do not use the device near a source of toxic or harmful vapors.</p> <p>When using oxygen with this system, turn the device on before turning on the oxygen. Turn the oxygen off before turning the device off. This will prevent oxygen accumulation in the device. <b>Explanation of the Warning:</b> When the device is not in operation and the oxygen flow is left on, oxygen delivered into the tubing may accumulate within the device's enclosure. Oxygen accumulated in the device enclosure will create a risk of fire.</p>
<p><b>EMC</b></p>	<p>Medical Electrical Equipment needs special precautions regarding EMC and needs to be installed and put into service according to the EMC information provided in this manual. The device should not be used adjacent to or stacked with other equipment. For more information, contact your home care service provider.</p> <p>Portable and Mobile RF Communications Equipment can affect Medical Electrical Equipment. See the EMC section of this manual for distances to observe between RF Generators and the ventilator to avoid interference.</p> <p>The Health Industry Manufacturers Association recommends that a minimum separation of six inches be maintained between a wireless phone and a pacemaker to avoid potential interference with the pacemaker. The DreamStation on-board <i>Bluetooth</i> communication should be considered a wireless phone in this regard.</p>

<b>Maintenance</b>	Never operate the device if any parts are damaged or if it is not working properly. Replace damaged parts before continuing use.
	Periodically inspect electrical cords, cables, tubing, and accessories for damage or signs of wear. Discontinue use and replace if damaged.
	Repairs and adjustments must be performed by Philips Respironics-authorized service personnel only. Unauthorized service could cause injury, invalidate the warranty, or result in costly device damage. Contact your home care service provider for maintenance.
<b>Cleaning</b>	To avoid electrical shock, always unplug the power cord from the wall outlet before cleaning the device.
	Do not immerse the device in any fluids or spray the device with water or cleaners. Clean the device with a cloth dampened with an approved cleaner.
<b>Humidifier</b>	For safe operation when using a humidifier, the humidifier must always be positioned below the breathing circuit connection at the mask. The humidifier must be level for proper operation.

### 1.3.2 Cautions

A caution indicates the possibility of damage to the device.

<b>Electrostatic Discharge (ESD)</b>	Do not use antistatic or conductive hoses or conductive patient tubing with the device.
	Pins of connectors marked with the ESD warning symbol shall not be touched and connections shall not be made without special precautions. Precautionary procedures include methods to prevent build-up of electrostatic charge (e.g., air conditioning, humidification, conductive floor coverings, non-synthetic clothing), discharging one's body to the frame of the equipment or system or to earth. It is recommended that all individuals that will handle this device understand these precautionary procedures at a minimum as part of their training.
	Before operating the device, ensure that the SD card/filter access door and the modem access door are both closed whenever any of the accessories such as the Link Module or Modem are not installed. Refer to the instructions that came with your accessory.
<b>Condensation</b>	Condensation may damage the device. If the device has been exposed to either very hot or very cold temperatures, allow it to adjust to room temperature (operating temperature) before starting therapy. Do not operate the device outside of the operating temperature range shown in the Specifications chapter later in this manual.



<b>Filters</b>	A properly installed, undamaged Philips Respironics blue pollen filter is required for proper operation.
	Clogged inlet filters may cause high operating temperatures that may affect device performance. Regularly examine the inlet filters as needed for integrity and to check for accumulated debris.
	Never install a wet filter into the device. You must ensure sufficient drying time for the rinsed filter.
<b>Extension cords</b>	Do not use extension cords with this device.
<b>DC power</b>	Always ensure that the DC power cord securely fits into your therapy device prior to use. Contact your home care service provider to determine if you have the appropriate DC cord for your specific therapy device.
	When DC power is obtained from a vehicle battery, the device should not be used while the vehicle's engine is running. Damage to the device may occur.
	Only use a Philips Respironics DC power cord and battery adapter cable. Use of any other system may cause damage to the device.
<b>Device placement</b>	Do not place the device in or on any container that can collect or hold water.
	Do not place the device directly onto carpet, fabric, or other flammable materials.
	Do not plug the device into an outlet controlled by a wall switch.
<b>Tobacco use</b>	Tobacco smoke may cause tar build up within the device.
<b>Humidifier</b>	The heated humidifier can only be used when the ventilator is connected to AC power. It cannot be used with a battery.
<b>Cleaning</b>	Do not immerse the device or allow any liquid to enter the enclosure or the inlet filter.
	Do not steam autoclave the ventilator. Doing so will destroy the ventilator.
	Do not use harsh detergents, abrasive cleaners, or brushes to clean the ventilator system.

### 1.3.3 Notes

- This product is not made with DEHP, natural latex rubber or dry natural rubber in patient or operator accessible areas or in the air path or breathing circuit.
- See the Limited Warranty section of this manual for information warranty coverage.

### 1.3.4 Contraindications

The device is contraindicated on patients without a spontaneous respiratory drive. If any of the following conditions apply to you, consult your physician before using the device:

- Inability to maintain a patent airway or adequately clear secretions
- At risk for aspiration of gastric contents
- Diagnosed with acute sinusitis or otitis media
- Allergy or hypersensitivity to the mask materials where the risk from allergic reaction outweighs the benefit of ventilatory assistance
- Epistaxis, causing pulmonary aspiration of blood
- Hypotension

When assessing the relative risks and benefits of using this equipment, the health care professional should understand that this device can deliver the pressure ranges indicated in the Control Accuracy table in chapter 6. In the event of certain fault conditions, a maximum pressure of 60 cmH<sub>2</sub>O is possible.

#### Warning

**Physicians should assess individual patient risks before prescribing autoSV therapy for patients with chronic, symptomatic heart failure (NYHA II-IV) with left ventricular ejection fraction below 45% and moderate to severe predominant central sleep apnea.**















**The physician should assess the relative risks and benefits of autoSV therapy on a case-by-case basis in patients with severe heart conditions including unstable angina or unstable arrhythmias.**

### 1.3.5 Patient precautions

- Immediately report any unusual chest discomfort, shortness of breath, or severe headache.
- If skin irritation or breakdown develops from the use of the mask, refer to the mask instructions for appropriate action.
- The following are potential side effects of noninvasive positive pressure therapy:
  - Ear discomfort
  - Conjunctivitis
  - Skin abrasions due to noninvasive interfaces
  - Gastric distention (aerophagia)

## 1.4 Symbol key

The following symbols may appear on the device, power supply, and accessories:

Symbol	Definition	Symbol	Definition
	Consult accompanying instructions for use.		For airline use. Complies with RTCA/DO-160G section 21, category M.
	AC power		Separate collection for electrical and electronic equipment per EC Directive 2012/19/EU.
	DC power		Bluetooth® symbol
IP22	Drip proof equipment		This device contains an RF transmitter.
	Caution, consult accompanying documents.	SpO <sub>2</sub>	Oximeter connection
	ESD warning symbol	○ ○	Serial connection
	Class II (Double Insulated)		Avoid ultraviolet radiation
	Type BF applied part		Do not disassemble.
	For indoor use only		Audio pause

## 1.5 System overview

### 1.5.1 Device description

The device is intended to augment patient breathing by supplying pressurized air through a patient circuit. It senses the patient's breathing effort by monitoring airflow in the patient circuit and adjusts its output to assist in inhalation and exhalation. This therapy is known as Bi-level ventilation. Bi-level ventilation provides a higher pressure, known as IPAP (Inspiratory Positive Airway Pressure), when you inhale, and a lower pressure, known as EPAP (Expiratory Positive Airway Pressure), when you exhale. The higher pressure support your inhalation, and the lower pressure makes it easier for you to exhale.

When prescribed, the device can also provide features to help make your therapy more comfortable. The ramp function allows you to lower the pressure when trying to fall asleep. The air pressure will gradually increase until the prescription pressure is reached. Additionally, the Flex comfort feature provides increased pressure relief during the expiratory phase of breathing.

Several accessories are also available for use with the device. Contact your home care service provider to purchase any accessories not included with your system.

### 1.5.2 Therapy features

If prescribed for you, the device provides the following therapy features.

#### 1.5.2.1 Bi-Flex comfort feature

If enabled, the device provides a comfort feature called Bi-Flex. The Bi-Flex attribute adjusts therapy by inserting a small amount of pressure relief during the latter stages of inspiration and during active exhalation (the beginning part of exhalation). Bi-Flex levels of 1, 2, or 3 progressively reflect increased pressure relief that will take place at the end of inspiration and at the beginning of expiration.

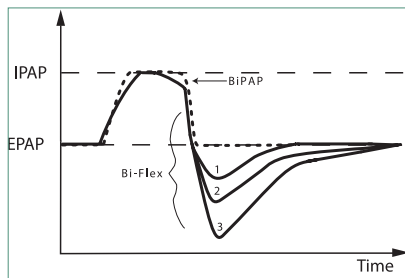

### 1.5.2.2 Ramp

If enabled, the device is equipped with a linear ramp function. The Ramp feature will reduce the pressure and then gradually increase (ramp) the pressure to the prescription pressure setting so patients can fall asleep more comfortably.

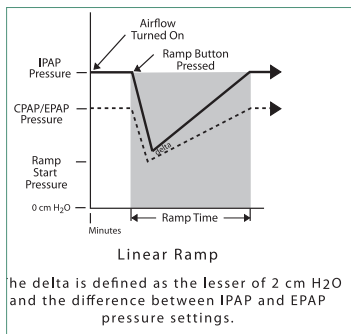

### 1.5.2.3 Rise time comfort feature

If enabled, the device provides a comfort feature called Rise Time. Rise time is the amount of time it takes the device to change from the expiratory pressure setting to the inspiratory pressure setting. Rise time levels of 1-6 progressively reflect slowed response of the pressure increase that will take place at the beginning of inspiration. A setting of 1 is the fastest rise time while a setting of 6 is the slowest. Providers should adjust the rise time to find the most comfortable setting for the patient. Rise time cannot be adjusted when Bi-Flex is enabled.





### 1.5.2.4 Digital Auto-Trak

Digital Auto-Trak is an important ventilation feature due to its ability to recognize and compensate for unintentional leaks in the patient circuit. Digital Auto-Trak is an automated process that maintains optimum ventilator performance in the presence of leaks. The device continuously monitors the actual circuit and adjusts an internal estimate of patient flow as natural variations in the circuit leak occur. As unintentional circuit leaks occur, the triggering and cycling algorithms ensures optimum patient and machine synchrony. It also provides a high degree of accuracy for calculation of flow-based parameters, such as exhaled tidal volume.

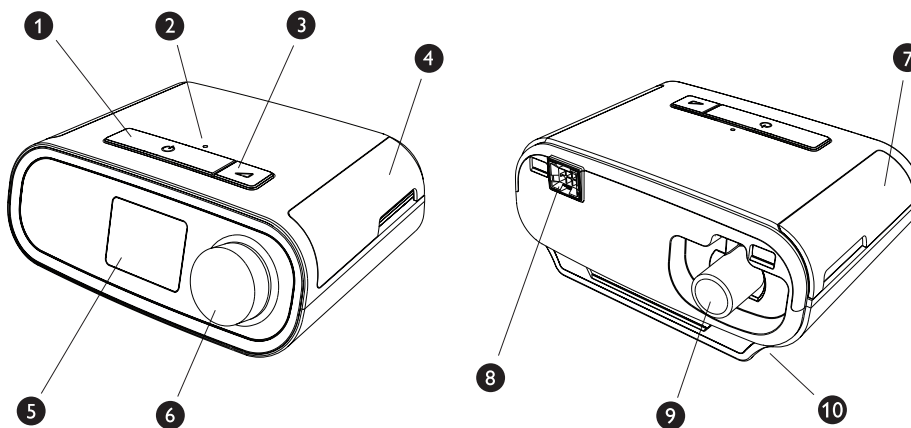
### 1.5.3 Device features



The figure above illustrates some of the device features, described in the following table.

#	Feature	Description
1	Therapy on/off button 	Starts and stops the airflow for therapy.
2	Ambient light sensor	Detects room light levels and adjusts brightness of LCD display screen.
3	Ramp button 	Activates the ramp feature during therapy.
4	Door, SD card & filter access	This door lifts open for access to the SD card and filter area.
5	LCD display screen	This is the User Interface for the therapy device.
6	Control dial	Turn the dial to scroll between options on the screen. Press the dial to choose an option and silence and acknowledge alarms.
7	Door, accessory access	This door lifts open for access to the (optional) accessories.
8	Humidifier connector	Humidifier connects to the back of the therapy device. The humidifier pin connector will attach here.
9	Air outlet port	Connect the tubing here.
10	Power inlet	Connect the power cord here.

## 1.6 How to contact Philips Respironics

Should you experience trouble with this equipment or require assistance setting up, using, or maintaining the device or accessories, please contact your home care service provider. To contact Philips Respironics directly, use the following contact details:

Respironics, Inc.  
1001 Murry Ridge Lane  
Murrysville, PA 15668  
1-724-387-4000

Deutschland  
Gewerbestrasse 17  
82211 Herrsching, Germany  
+49 8152 93060

## 2. Device setup

This chapter details how to set up the DreamStation BiPAP autoSV device. This chapter includes:

- Installing the air filter
- Positioning the device
- Connecting the breathing circuit
- Supplying AC power to the device
- Menu and screen navigation
- *Bluetooth* and Wi-Fi setup

### 2.1 Installing and replacing the air filters

#### Caution

**A properly installed, undamaged Philips Respironics blue pollen filter is required for proper operation.**

The device uses a reusable blue pollen filter that can be rinsed and a disposable light-blue ultra-fine filter. The reusable blue filter screens out pollens, while the light-blue ultra-fine filter provides more complete filtration of very fine particles. The reusable blue filter must be in place at all times when the device is operating. The ultra-fine filter is recommended for people who are sensitive to tobacco smoke or other small particles.

The reusable blue filter is supplied with the device. A disposable light-blue ultra-fine filter may also be included. If your filter is not already installed when you receive your device, you must at least install the reusable filter before using the device.

This device has an automatic air filter reminder. Every 30 days, the device will display a message reminding you to check your filters and replace them as directed.

#### Note

This message is a reminder only. The device does not detect the performance of the filters nor does it recognize when a filter has been rinsed or replaced.

1. Lift up on the filter access door and swing open. If replacing, pull out the old filter assembly.

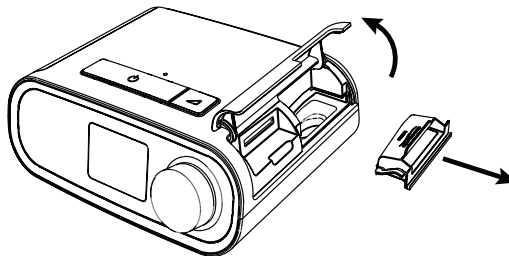



2. If applicable, place a dry, reusable blue pollen filter (1) on top of a new, optional disposable light-blue ultra-fine filter (2) and firmly snap them together.

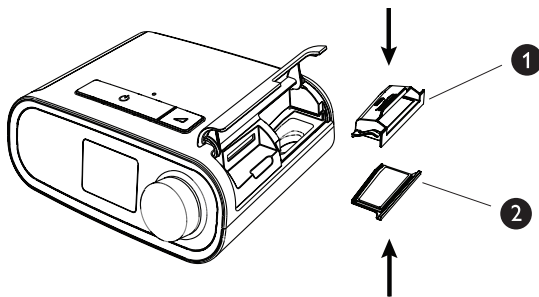

3. Place the new filter assembly back in the side of the therapy device. Swing the door closed.

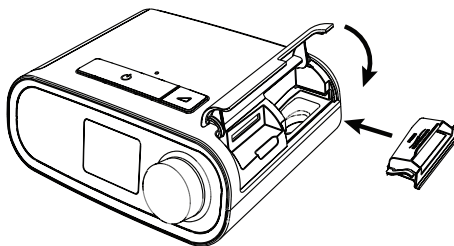

## 2.2 Positioning the device

Place the device on a firm, flat surface somewhere within easy reach of where you will use it at a level lower than your sleeping position. Make sure the device is away from any heating or cooling equipment (e.g., forced air vents, radiators, air conditioners).

### Note

When positioning the device, make sure that the power cable is accessible because removing power is the only way to turn off the device.

### Cautions

**Make sure the filter area on the side of the device is not blocked by bedding, curtains, or other items. Air must flow freely around the device for the system to work properly.**

**Do not place the device directly onto carpet, fabric, or other flammable materials.**

**Do not place the device in or on any container that can collect or hold water.**

## 2.3 Supplying AC power to the device

Complete the following steps to operate the device using AC power:

1. Plug the socket end of the AC power cord (included) into the power supply (also included).
2. Plug the pronged end of the AC power cord into an electrical outlet that is not controlled by a wall switch.

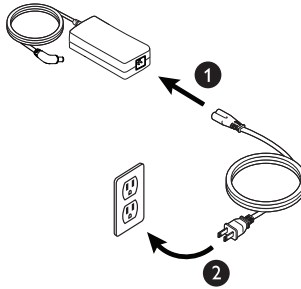

3. Plug the power supply cord's connector into the power inlet on the side of the device.

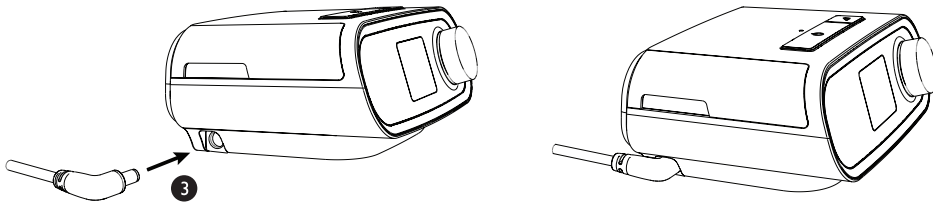

4. Verify that the plug at the side of the device, at the power supply, and at the electrical outlet are fully inserted. This will help to ensure that a secure, reliable electrical connection has been made.

### Note

If the Incorrect Power Supply icon appears on the screen, please repeat step 4. 

### Important

To remove AC power, disconnect the power supply cord from the electrical outlet.

### Warning

Periodically inspect electrical cords and cables for damage or signs of wear. Discontinue use and replace if damaged.

### Caution

Do not use extension cords with this device.

## 2.4 Connecting the breathing circuit

To use the system, you will need the following accessories in order to assemble the recommended breathing circuit:

- Philips Respironics interface (nasal mask or full face mask) with integrated exhalation port, or Philips Respironics interface with a separate exhalation device (such as the Whisper Swivel II)
- Philips Respironics flexible tubing, 1.83 m (6 ft.)
- Philips Respironics headgear (for the mask)

To connect your breathing circuit to the device, complete the following steps:

1. Connect the flexible tubing to the air outlet on the back of the therapy device. Line up the connector (1) at the top of the heated tube to the top of the air outlet port on the back of the device.

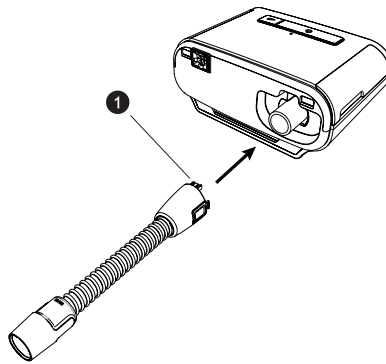

2. Press the tubing into place over the air outlet port until the tabs on the side of the tube click into place in the slots on the sides of the outlet port.

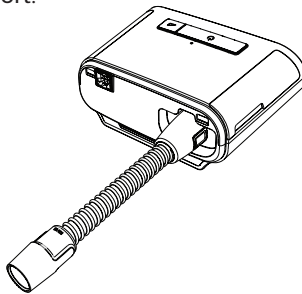

## Notes

If you are using a standard tube (not shown) instead of a heated tube, simply slide the tubing over the air outlet port on the therapy device.

If the device is being used by multiple persons in a hospital environment, connect a bacteria filter to the device air outlet, and then connect the flexible tubing to the outlet of the bacteria filter. When using the bacteria filter, the device performance may be affected. However, the device will remain functional and deliver therapy.

3. Connect the tubing to the mask. For proper placement and positioning, refer to the instructions that came with your mask.

### Warnings

**Do not pull or stretch the tubing. This could result in circuit leaks.**

**Inspect the tubing for damage or wear. Discard and replace the tubing as necessary.**

4. Attach the headgear to the mask if necessary. Refer to the instructions that came with your headgear.

### Warnings

**If you are using a full face mask (a mask covering both your mouth and your nose), the mask must be equipped with a safety (entrainment) valve.**

**An exhalation port is required. Do not block the exhalation port. This can reduce airflow and result in rebreathing of exhaled air.**

**If the device is used by multiple persons (such as rental devices), a low-resistance, main flow bacteria filter should be installed in-line between the device and the circuit tubing to prevent contamination.**

## 2.5 Starting the device

1. Ensure power is supplied to the device. The first screen to display will be the Philips Respironics logo, followed by the device model screen, and then the Home screen.

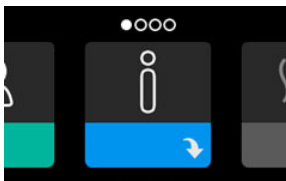

The first time the device is powered on, a pop-up will prompt you to set the time on the device. The default setting is Greenwich Mean Time, but you may adjust the time in 30 minute increments to match your local time zone. If you choose to skip this initial time setting, the time can always be adjusted under the My Setup menu.

### Note

This time setting is not displayed as a clock function on the device. It is only used to align your therapy data for your home care service provider's data reports.

2. Put on your mask assembly. Refer to the instructions supplied with the mask.
3. Press the Therapy button () on top of the device to turn on airflow and begin therapy. The current delivered pressure will display on the screen.
4. Make sure that no air is leaking from your mask. If necessary, adjust the mask and headgear until the air leak stops. See the instructions provided with your mask for more information.

**Note**

A small amount of mask leak is normal and acceptable. Correct large mask leaks or eye irritation from an air leak as soon as possible.

5. If you are using the device in a bed with a headboard, try placing the tubing over the headboard. This may reduce tension on the mask.
6. Press and hold the Therapy button for 2 seconds to turn off therapy.



**Note**

During therapy, if there is a mains interruption (i.e. power loss) the device will return to the Home screen once power is restored. You may resume therapy as needed.



## 2.6 Navigating the device screens

The User Interface (UI) on this device allows you to adjust the device settings and view information about your therapy. The UI is composed of the display screen and the control dial. Rotate the control dial in either direction to scroll through the menus on the display screen. Press the control dial to open a menu.

To adjust a setting:

1. Rotate the control dial to your desired setting.
2. Press the control dial to select that setting.
3. Rotate the control dial to change the setting. The rotate dial icon  on any screen indicates to rotate the dial to perform an action.
4. Press the control dial again to save the setting change. The click dial icon  on any screen indicates to press the dial to perform an action.

**Notes**



Pressing the dial when the down arrow  appears on any screen will take you to a sub-menu with more menu options. Pressing the dial when the up arrow  appears on any sub-menu will return you back to the main menu.

The screens shown throughout this guide are examples for reference only. Actual screens may vary based upon device model and provider settings.

## 2.7 Therapy screen features and optional humidification settings

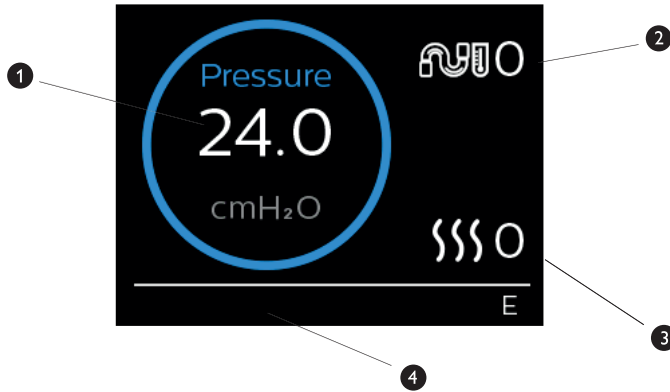
The following screen is displayed while therapy is turned on. The table below describes the different features that may appear on your screen. If an accessory is attached to the therapy device, additional symbols may appear. Refer to the instructions provided with the accessory for more information.



#	Feature	Description
1	Therapy pressure	Displays the current delivered pressure.
2	Adjustable tube temperature setting	You can change this setting from 0 to 5. Only displays when optional heated tube is connected.
3	Adjustable humidifier setting	You can change this setting from 0 to 5. Only displays when humidifier is attached.
4	Enabled features	If enabled, the following therapy features will display here: <ul style="list-style-type: none"> <li>• Opti-Start</li> <li>• Humidifier </li> <li>• I or E - indicates IPAP or EPAP state</li> <li>• Patient breath indication </li> </ul>

**Note**

The Patient menu screens may be accessed during therapy by pressing the Therapy button (⏻). The Home screen will appear, allowing for navigation through the My Info, My Provider, and My Setup menus. See **Patient menu navigation** later in this chapter for additional details on each menu. The Preheat menu is not available while therapy is turned on.

## 2.7.1 Adjusting the humidifier and heated tube settings

If you have a humidifier, you can adjust tube temperature or humidifier settings while the device is delivering therapy by following these steps:

1. Turn the control dial counter-clockwise to activate the humidifier setting and clockwise to activate the heated tube setting.
2. Press the control dial to edit the setting.
3. Turn the control dial until you reach the desired setting. The setting increments when you turn the dial clockwise and decrements when you turn the dial counter-clockwise.
4. Press the control dial to save the setting.

### Note

If you are using the humidifier without the heated tube, simply just rotate the control dial in either direction to change the humidifier setting.

## 2.7.2 Ramp feature

The device is equipped with an optional ramp feature that your home care service provider can enable or disable. This feature reduces the air pressure when you are trying to fall asleep and then gradually increases (ramps) the pressure until your prescription setting is reached, allowing you to fall asleep more comfortably.

If ramp is enabled on your device, after you turn on the airflow, press the Ramp (  ) button on the top of the device. You can use the Ramp button as often as you wish during the night.

When you click the Ramp button, the Therapy screen will change to reflect the Ramp pressure, and the blue circle will reflect the gradual increase in pressure.



Your device has two ramp modes. Your provider will select the one that is most appropriate for you. The standard ramp mode increases pressure at a steady rate. Alternately, the SmartRamp mode maintains a constant lower pressure until the device detects that you require more pressure.

## 2.8 Patient menu navigation

From the Home screen, you can scroll between the following four options:

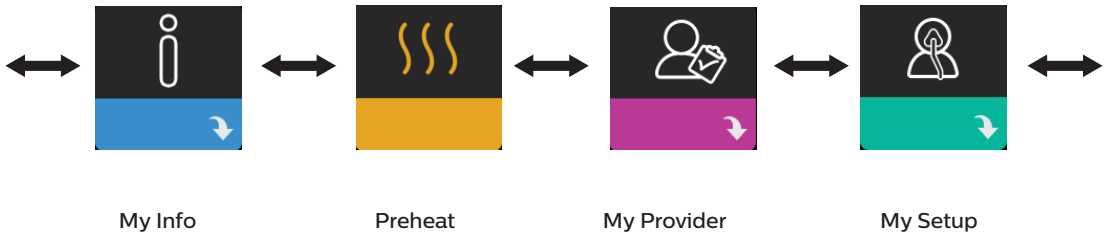

My Info	This menu provides summary statistics of your therapy use.
Preheat	This function lets you warm up your humidifier for 30 minutes before starting a therapy session. This only displays when a humidifier is attached to your device. <b>Note</b> The Preheat menu is not available while therapy is turned on.
My Provider	This menu contains information that your provider may direct you to read to them so they can better assist you over the phone.
My Setup	This menu contains comfort settings that you can adjust as needed.

### 2.8.1 My Info



When you select **My Info**, you will be able to view the following screens. You cannot change settings in the My Info menu. These screens are only for reference. Your home care provider may periodically ask you for this information.

#### Note

Additional icons may appear if optional accessories are being used (such as the oximetry module). Refer to the manual that accompanies the accessory for more information.

Icon	Text	Description
	Therapy Hours	This screen displays the amount of time the user is actually receiving therapy on the device for the most recent 1-day time frame. It also displays the average amount of time the patient is actually receiving therapy over the last 7 days and 30 days.



Icon	Text	Description
<b>AHI</b>	AHI	This screen displays the nightly Apnea/Hypopnea Indices (AHI) value for the most recent 1 day time frame. It also displays the average of these individual nightly AHI values over a 7-day and a 30-day time frame. This screen only displays if your home care provider has enabled it.
	Mask Fit	Displays the value “100% minus Large Leak.” Large Leak is the percentage of time that the mask leak was so high that it is no longer possible for the device to identify respiratory events with statistical accuracy. Displays the value for the most recent 1 day, as well as the values over last 7 days and 30 days. This screen only displays if your home care provider has enabled it.
Periodic Breathing	Periodic Breathing	Displays the percentage of time that the user experienced periodic breathing. Displays the value for the most recent 1 day time frame, as well as values for the last 7 days and 30 days. If you observe a large increase in the percent of time in periodic breathing indicated here, contact your home care provider for assistance. This screen only displays if your home care provider has enabled it.
90% Pressure	90% Pressure	This screen displays the nightly value of 90% Pressure for the most recent 1 day time frame. It also displays the average of these individual nightly values of 90% Pressure over a 7 day and a 30 day time frame.

## 2.8.2 Preheat



### NOTE

This screen only displays when a humidifier is attached.

When using a humidifier, the device can preheat the water tank for up to 30 minutes prior to starting therapy.

In order to activate the preheat mode, the blower must be off and a humidifier must be attached. When **Preheat** is selected, you will be able to turn the control dial to choose between On or Off. Press the control dial again to make your selection. During the 30-minute preheat, you will still be able to use the control dial to select other menu options from the Home screen.

## 2.8.3 My Provider

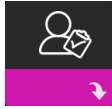





When you select **My Provider**, you will be able to view the following screens. You cannot change settings in the Provider menu. These screens are only for reference. Your home care provider may periodically ask you for this information.

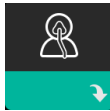







Icon	Text	Description
	Therapy	This screen displays your therapy settings. Settings cannot be adjusted from this screen.
	Alarms	This screen displays your alarm settings. Settings cannot be adjusted from this screen.
	Provider Contact Info	This screen will display the contact information for your provider if it has been uploaded to your device.
	Phone-In	This screen displays the total therapy hours for the device, the total blower hours, the total number of days used when the sessions were greater than 4 hours, and a compliance check number used by your home care service provider to validate that the data provided by you is the data taken from this screen.
	Compliance	This screen displays your start date, the total number of days used when the sessions were greater than 4 hours, and a check code number used by your home care service provider.
	Upload	Allows user to initiate a modem call when an optional cellular modem or Wi-Fi accessory is installed. Signal strength (  ) is indicated at the top right of this screen. After the modem upload has finished, the screen will either display a green check mark with the text <b>Completed</b> to indicate a successful upload, or a red X with the text <b>Failed</b> to indicate an unsuccessful upload. If the upload fails, initiate an upload a second time, or contact your home care provider if the issue persists. This screen is locked if modem is off.
	Device Info	This screen displays your therapy device information: serial number, model, and software version.
	Performance Check	Your device is equipped with a self-diagnostic tool called Performance Check. This tool can evaluate your device for certain errors. It also allows you to share key device settings with your home care service provider. Use Performance Check when directed to by your home care service provider. At conclusion of the scan, the screen displays a green check mark if no issue is detected. If device displays a red X, please contact your home care service provider for assistance.

## 2.8.4 My Setup



When you select **My Setup**, you will be able to view the following screens. You can change the settings in the Setup menu. These screens will only display if they are available and enabled on your device.

Icon	Text	Description
	Ramp	This displays the ramp starting pressure. You can increase or decrease the ramp starting pressure in 0.5 cm H <sub>2</sub> O increments. Note: If a lock icon  is displayed on this screen, it indicates that your provider has locked this setting and you cannot change it.
	Ramp time	This enables you to modify the Ramp time setting in 5 minute increments. The range for this setting is 0 to 45 minutes.
	Rise time	Rise time is the time it takes for the device to change from EPAP to IPAP. If rise time is prescribed for you, you can adjust the rise time from 1 to 6 to find the setting that provides you with the most comfort. A setting of 1 is the fastest rise time, while 6 is the slowest.
	Flex	This allows you to adjust the level of air pressure relief that you feel when you exhale during therapy. Your home care provider can enable or disable this feature. When your provider enables Flex, a level will already be set for you on the device. You can increase or decrease the setting from 1 to 3. The setting of 1 provides a small amount of pressure relief, with higher numbers providing additional relief. Note: If a lock icon  is displayed on this screen, it indicates that your provider has locked this setting and you cannot change it.
	Humidification	This displays the Humidification Mode being used. You can choose between Fixed or Adaptive Humidification. If a heated tube is being used, the device will automatically switch to Heated Tube Humidification Mode. A lock icon  will appear next to the mode setting indicating that so long as the heated tube is attached to the device, this mode cannot be changed. However, the heater plate and tube temperature settings can still be adjusted on the device Therapy screen as normal.
	Mask type	This setting allows you to adjust the level of air pressure relief based on the specific Philips Respironics mask. Each Philips Respironics mask may have a System One resistance control setting. Contact your home care provider if you cannot find this resistance setting for your mask. Note: If a lock icon  is displayed on this screen, it indicates that your provider has locked this setting and you cannot change it.

Icon	Text	Description
	Tube type	<p>This setting allows you to select the correct size diameter tubing that you are using with the device. You can choose either (22) for the Philips Respironics 22 mm tubing, or (15) for the Philips Respironics 15 mm tubing. When using Heated Tubing, the device will automatically change this setting to the appropriate tubing type (15H) and you will not be able to change it.</p> <p>Note: Tubing is identified on the cuff with the tubing identifier symbol: 15, 22 or 15H.</p> <p>Note: If a lock icon  is displayed on this screen, it indicates that your provider has locked this setting and you cannot change it.</p>
	Language	<p>This feature allows you to choose which language to display on the interface. You can also turn the language off (0), which means the device will only display icons on the interface.</p>
	Check mask fit	<p>This feature allows you to check the fit of your mask prior to starting therapy. This is done by measuring the amount of leak.</p>
Wi-Fi	Wi-Fi	<p>This feature allows you to setup or edit your Wi-Fi connection. It only displays when a Wi-Fi modem is installed and turned on.</p>
	Modem	<p>This feature allows you to turn the modem off temporarily or turn it back on. When the modem is turned off, it will automatically turn on again after 3 days. This feature only displays when modem is installed.</p>
	<i>Bluetooth</i>	<p>This feature allows you to turn <i>Bluetooth</i> off and on. Also, it allows you to clear the pairing with a compatible <i>Bluetooth</i> device.</p>
	Time	<p>This setting allows you to adjust the time. The default setting is Greenwich Mean Time, but you may adjust the time in 30 minute increments to match your local time zone.</p> <p>Note: This time setting is not displayed as a clock function on the device. It is only used to align your therapy data for your Provider's data reports.</p>
	Brightness	<p>This feature allows you to adjust the screen brightness. The default setting is Auto. You can change the setting from 20%-100% brightness.</p>

## 2.9 Connecting to Wi-Fi (if available)

If your device has a Wi-Fi accessory installed and enabled, follow the steps below to connect your device to Wi-Fi. For additional information, see the instructions included with your Wi-Fi accessory.

1. From the **My Setup** menu, select **Wi-Fi**.
2. The Wi-Fi accessory will search for available networks within range of your device. Press the control dial to select your network.

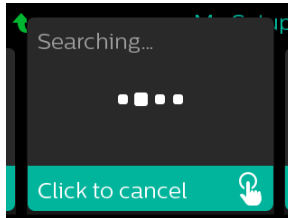

3. If your network is secure, a Passkey pop-up screen appears. Enter your network password, and then select the green check mark.



Once your password is entered, the Wi-Fi accessory will connect to your network. When the completed screen appears, press the control dial to close the screen.

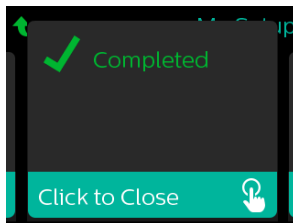

### Note

If a red X appears over the signal strength icon, the Wi-Fi accessory detects a wireless router but cannot connect to it. Try repeating steps 1-3 above, making sure you select the correct network and enter the correct password.

## 2.10 *Bluetooth*<sup>®</sup> wireless technology\*

Your device has Bluetooth wireless technology, which is one method by which you can transfer your therapy device's data to DreamMapper\*. DreamMapper is a mobile and web-based system designed to help sleep disordered breathing patients enhance their sleep therapy experience.

### 2.10.1 Pairing your therapy device to your *Bluetooth*-enabled mobile device

#### Notes

You will not receive alarms on your mobile device through the *Bluetooth* connection.

You can only pair your therapy device to one mobile device at any given time.

Pairing works best when your therapy device and mobile device are in the same room.

The current version of DreamMapper will guide you through these instructions.

After initiating pairing, you will have 30 seconds to complete the setup. After this time, it will be cancelled automatically.

Follow the steps below to manually pair to your mobile phone or tablet.

1. With your therapy device powered up and the blower off, initiate *Bluetooth* Setup from the DreamMapper mobile app.
2. If you need to select from a list of available *Bluetooth* devices, the therapy device will appear as **PR BT XXXX** (XXXX) will be the last four digits of the serial number listed on your therapy device).
3. Your mobile device will require you to confirm pairing via one of these two methods:

- Enter a PIN code

The following icon will appear on your therapy device screen with **Pair?**: 

Rotate the therapy device's control dial to select **Yes**, and press the control dial. Your therapy device will display a 6-digit PIN. Enter this PIN on your mobile device to complete pairing.

- Confirm a PIN code

The following icon will appear on your therapy device screen with a 6-digit PIN and **Pair?**:



Verify that the PIN is the same on both the therapy device and the mobile device. If so, rotate the therapy device's control dial to select **Yes** and then press the control dial. Then, accept on the mobile device to complete pairing.

\*Bluetooth wireless technology and DreamMapper are not available in all markets. For more information, please consult your local Philips Respironics representative.

## 2.10.2 Notices

The *Bluetooth*<sup>®</sup> word mark and logos are registered trademarks owned by Bluetooth SIG, Inc. and any use of such marks by Philips Respironics is under license. Other trademarks and trade names are those of their respective owners.

The DreamStation device is capable of transmitting data between the therapy device and a mobile device. This connection between the therapy device and a mobile device is encrypted.

This device contains a FCC certified *Bluetooth* radio module (located on the main board).

Only the co-location of this *Bluetooth* radio with the radio transceivers of the DreamStation Wi-Fi accessory and cellular modem has been FCC approved and is permitted.

For compliance with FCC RF exposure guidelines a minimum distance of 20 cm between the Wi-Fi accessory or the cellular modem and the user's body should be maintained during operation of one of those accessories together with the DreamStation.

FCC ID: THO1116426

THO1116426 is the FCC ID of the FCC certified *Bluetooth* module contained in this device.

Use of non-original manufacturer-approved accessories may violate your local RF exposure guidelines and should be avoided.

This device complies with part 15 of the FCC Rules. Operation is subject to the following two conditions: (1) This device may not cause harmful interference, and (2) this device must accept any interference received, including interference that may cause undesired operation.

This equipment has been tested and found to comply with the limits for a Class B digital device, pursuant to Part 15 of the FCC Rules. These limits are designed to provide reasonable protection against harmful interference in a residential installation. This equipment generates, uses, and can radiate radio frequency energy and, if not installed and used in accordance with the instructions, may cause harmful interference to radio communications. However, there is no guarantee that interference will not occur in a particular installation. If this equipment does cause harmful interference to radio, TV reception, or other devices which can be determined by turning the equipment on and off, the user is encouraged to try to correct the interference by one or more of the following measures:

- Reorient or relocate the receiving antenna (on the radio, TV, or other device).
- Increase the separation between the equipment and receiver.
- Connect the equipment into an outlet on a circuit different from that to which the receiver is connected.
- Consult the dealer of the device for help.

Any changes or modifications made to the device that are not expressly approved by Respironics may void the user's authority to operate the equipment.

### CE Notice

Hereby, Respironics, Inc. declares that this Class 1 radio equipment is in compliance with Directive 2014/53/EU. The full text of the EU declaration of conformity is available at the following internet address: <http://incenter.medical.philips.com/PMSPublic>

## 2.11 Check mask fit

The optional Check Mask Fit feature can be enabled or disabled by your home care provider. This feature allows you to check the fit of your mask prior to starting therapy. This is done by measuring the amount of leak. Put on your mask assembly. Refer to your mask instructions if needed. Navigate to the Check Mask Fit screen under **My Setup**, and press the control dial to start the check.

The device will deliver a test pressure while the screen counts down 40 seconds. A green bar indicates good fit, while a red bar indicates improvement is needed. After the test, normal therapy will start and the screen will either display a green check mark or a red X. The green check mark indicates that the leak found allows for optimal performance of the device. The red X indicates that the leak may affect device performance, however, the device will remain functional and deliver therapy.



### Note

If you choose to try to improve your mask fit, you can stop therapy, adjust the fit of your mask, and rerun the Check Mask Fit. Refer to the instructions that came with your mask and headgear for the proper fitting procedure.

## 2.12 Sleep progress

Your device provides summary information about your therapy use each time the therapy is turned off. The screen displays your **Three Night Summary**. It shows your nightly usage for the last 3 sleep sessions (measured in 24 hour periods, ending at noon each day). The most recent session is displayed in the right hand bar, labeled with the number of hours slept. A green bar indicates that you slept more than 4 hours, and a yellow bar indicates less than 4 hours of use.

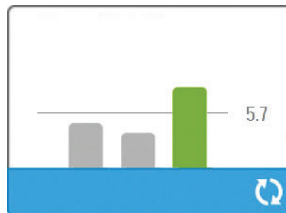



## 2.13 Altitude compensation

This device automatically compensates for altitude up to 7,500 feet. No manual adjustment is necessary.

# 3. Alarms, alerts, and troubleshooting

This chapter describes the alarms and alerts and what you should do if an alarm or alert occurs. Reference the Troubleshooting section if you experience any problems while using the device.

## 3.1 Device alarms

There are two types of alarms:

- High priority - Require immediate response by the operator.
- Medium priority - Require prompt response by the operator.

When an alarm condition occurs:

- The audio pause icon appears and the control dial LED indicator lights.
- The audible alarm sounds.
- A message appears on the screen describing the type of alarm.

## 3.2 Device alerts

Alerts are informational and confirmation messages that notify you of conditions that require attention but are not alarm conditions. Most alerts do not appear while therapy is being delivered. The different types of alerts are:

- Status - Message appears on the screen.
- Notification - Message appears on the screen and Therapy button LED flashes.
- Alert - Message appears on the screen, Therapy button LED flashes, and audible sound beeps once while alert is displayed.

## 3.3 Alarm and alert LED indicators

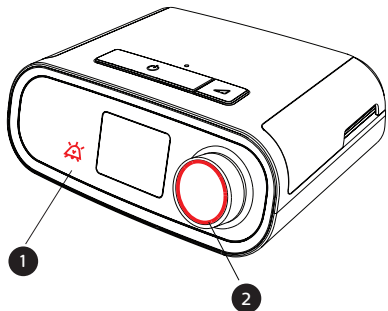

Red flashing alarm LED

When a high priority alarm is detected, the audio pause icon (1) and control dial LED (2) flash red.

Yellow flashing alarm LED

When a medium priority alarm is detected, the audio pause icon (1) and control dial LED (2) flash yellow.

Flashing Therapy button LED

When an alert or notification message appears on the screen, the Therapy button LED flashes. If the alert occurs while therapy is being delivered, the alert or notification will appear on the screen, but the LED will not flash.

### 3.4 Alarm and alert audible indicators

An audible indicator sounds when any of the following occurs:

- A device inoperative condition occurs
- The blower is on and a power failure occurs
- An alarm condition occurs
- An alert message appears on the screen

Alarm/alert type	Audible indicator
Device Inoperative	When a device inoperative alarm occurs, a continuous audible indicator sounds. 
Power failure	When a power failure occurs, a series of beeps sounds in a 1-beep pattern, repeating one second on, then one second off. • •
High priority	When a high priority alarm is active, a series of beeps sounds in the following pattern, which is repeated twice: 3 beeps, a pause, and then 2 more beeps. This indicator continues until the cause of the alarm is corrected or the audible alarm is silenced. ••• •• ••• ••
Medium priority	When a medium priority alarm is active, a series of beeps sounds in a 3-beep pattern. This pattern repeats until the cause of the alarm is corrected or the audible alarm is silenced. •••
Alerts	When an alert appears on screen, a brief, 1-beep audible indicator sounds. •

### 3.5 Silencing an alarm

You can temporarily silence an alarm by pressing the control dial. The alarm is silenced for 60 seconds and then sounds again if the cause of the alarm has not been corrected. If another alarm occurs while the silence period is active, the audible alarm portion of the new alarm will not sound until the silence period expires. When the silence period expires, the alarm’s audible alarm is reactivated if the alarm condition has not been corrected.

## 3.6 Alarm message screens

When an alarm message is activated, an alarm screen is displayed, showing the text or icon specific to the most recent, highest priority alarm.

Pressing the control dial once will silence the audible alarm. Press the control dial again to remove the alarm screen from the display. Resetting the alarm allows you to return to the previous screen. If multiple alarms occur during the same period of time, the alarm screen will display the higher priority alarm (higher priority alarms take precedence over lower priority alarms).



## 3.7 What to do when an alarm occurs

Complete the following steps when an alarm occurs:

1. Observe the patient and ensure that adequate ventilation and oxygenation (if appropriate) are available.
2. Listen to the audible alarm and look at the alarm indicators and whether the LED is solid or flashing.
3. Look at the display to check the alarm message that appears on-screen and whether it is red or yellow.
4. Press the control dial to temporarily silence the audible alarm. Or, press the control dial twice to acknowledge and remove the alarm from the screen. In case of loss of power, use the control dial to both silence and terminate the alarm.
5. Look up the alarm in the alarm descriptions in this chapter to determine the source of the alarm and the appropriate action.

### 3.8 Alarm summary table

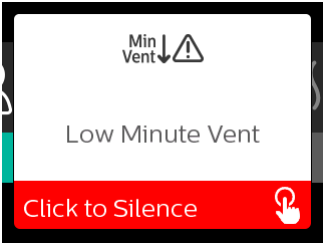
The following table summarizes the alarms. See **Alarm and alert LED indicators** and **Alarm and alert audible indicators** earlier in this chapter for LED and audible indicators for each alarm type.

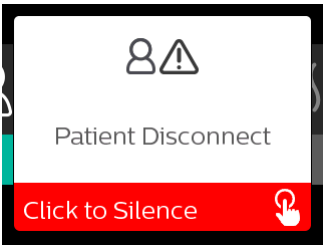
Alarm	Priority	Device action	User action
Physiological alarms			
 <p>The screen displays 'Min Vent' with a downward arrow and a warning triangle icon, followed by 'Low Minute Vent'. At the bottom, there is a red bar with the text 'Click to Silence' and a hand icon.</p>	High	Operates	This alarm occurs when the calculated minute ventilation is less than or equal to the alarm setting. Press the control dial to silence the alarm. Press the control dial again to acknowledge and remove the alarm from the screen. <b>Report the alarm to your home care service provider. Continue using your device.</b>
 <p>The screen displays a large 'A' with a warning triangle icon, followed by 'Apnea'. At the bottom, there is a red bar with the text 'Click to Silence' and a hand icon.</p>	High	Operates	This alarm occurs when the patient has not triggered a breath within the time specified in the apnea alarm setting. The device continues to operate. The alarm will automatically terminate when two consecutive patient breaths are detected that meet the apnea alarm time setting. Press the control dial to silence the alarm. Press the control dial again to acknowledge and remove the alarm from the screen. <b>Report the alarm to your home care service provider. Continue using your device.</b>
 <p>The screen displays a person icon with a warning triangle icon, followed by 'Patient Disconnect'. At the bottom, there is a red bar with the text 'Click to Silence' and a hand icon.</p>	High	Operates	This alarm occurs when the patient circuit is disconnected or has a large leak. Press the control dial to silence the alarm. Press the control dial again to acknowledge and remove the alarm from the screen. Reconnect the patient circuit or fix the leak. If the alarm continues, contact your home care service provider.

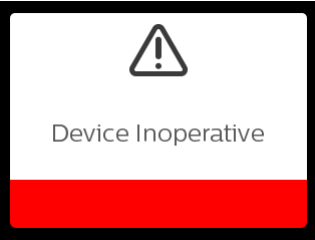
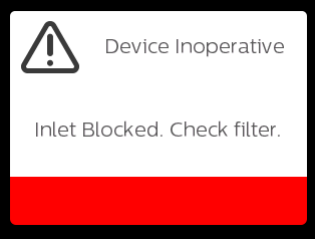
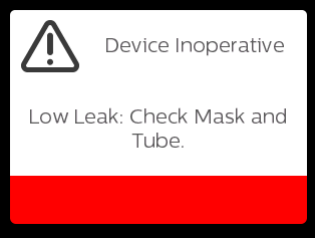
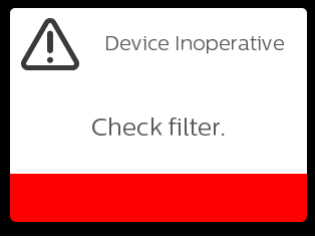

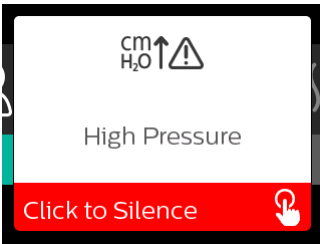
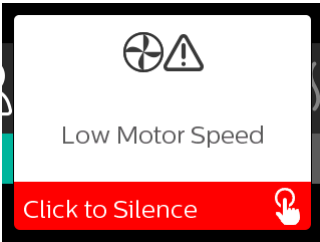
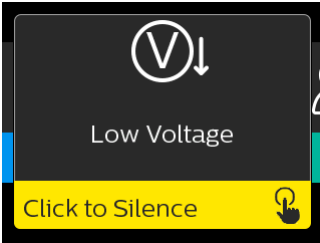

Alarm	Priority	Device action	User action
	Device inoperative	Shuts down	Press the control dial to silence the alarm. Disconnect the device from power. Immediately remove patient from ventilator and connect them to alternate source of ventilation. Contact your home care service provider for service.
	Device inoperative	Shuts down	Check device air inlet is not obstructed. Check air filter(s) are installed properly; replace if needed. If the alarm continues, contact your home care service provider for service.
	Device inoperative	Shuts down	Check tube is not crushed or folded such that air flow is restricted. Check mask is attached properly and without any obstruction. If the alarm continues, contact your home care service provider for service.
	Device inoperative	Shuts down	Remove your mask, and remove power from the device. Rinse or replace the reusable air filter or replace the disposable ultra-fine filter. Power device on and resume normal usage. If the alarm continues, contact your home care service provider for service.
Loss of power (blank screen)	Power failure	Shuts down	Press the control dial to silence the alarm. Remove your mask. Check your power connections. Make sure there is power at the outlet or power source. If the alarm continues, contact your home care service provider.

Alarm	Priority	Device action	User action
	High	Operates	<p>This could be caused by an excessive leak, blockage, or a device malfunction. Press the control dial to silence the alarm. Press the control dial again to acknowledge and remove the alarm from the screen. Remove your mask. Check for the following: dirty inlet filters, blocked air intake, excessive leak in the patient circuit. If the alarm continues, contact your home care service provider.</p>
	High	Operates; if the alarm continues for 10 seconds, the alarm escalates to a device inoperable alarm.	<p>This may be caused by a malfunctioning device. Press the control dial to silence the alarm. Press the control dial again to acknowledge and remove the alarm from the screen. Remove your mask, and remove power from the device. Restore power. If the alarm continues, contact your home care service provider for service.</p>
	High	Operates	<p>This may be caused by a malfunctioning device. Press the control dial to silence the alarm. Press the control dial again to acknowledge and remove the alarm from the screen. Remove your mask, and remove power from the device. Restore power. If the alarm continues, contact your home care service provider for service.</p>
	Medium	Operates	<p>Press the control dial again to acknowledge and remove the alarm from the screen. Remove your mask. Remove power from the device. Confirm a compatible Philips Respironics power supply is attached. Switch to compatible power supply, if needed. If battery is being used, ensure battery is adequately charged.</p>

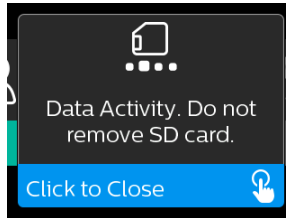



### 3.9 Alert summary table







The following table summarizes the alerts. See **Alarm and alert LED indicators** and **Alarm and alert audible indicators** earlier in this chapter for LED and audible indicators for each alert type. The screen below is an example of an alert screen. The icons shown in the table below appear on the top of each alert screen.





Alert	Icon	Priority	Description	User action
Data Activity: Do not remove SD card.		Status	SD card read/write underway.	No action needed.
Change Accepted		Status	Confirms acceptance of prescription change or device upgrade.	No action needed.
Oximetry: Good Connection (icon only)		Status	Displays on the therapy screen when the blower is on and 3 seconds of good connection is detected. Appears at the beginning of therapy. This screen will not display again if the oximetry sensor is removed and reapplied unless therapy is stopped and restarted.	No action needed.
Pair?: 123456 Yes/No		Status	Prompts to accept or decline pairing to a <i>Bluetooth</i> compatible device. This device can be identified by the digits displayed.	Rotate the control dial to accept pairing (Yes), or decline (No), then press the control dial to confirm selection.



Alert	Icon	Priority	Description	User action
Pair? Yes/No		Status	Prompts to accept or decline pairing to a <i>Bluetooth</i> compatible device.	Rotate the control dial to accept pairing (Yes), or decline (No), then press the control dial to confirm selection. Selecting Yes opens the <i>Bluetooth</i> passkey screen.
Flow Sensor Error: Limited Therapy		Notification	Flow sensor malfunction.	Press the control dial to acknowledge and clear the message. Disconnect the device from power. Immediately remove patient from ventilator and connect them to alternate source of ventilation. Contact your home care service provider for service.
SD Card Removed.		Notification or Alert	Indicates SD card has been removed from therapy device and not reinserted before the start of the current therapy session.	Reinsert SD card, or press the control dial to clear alert.
Oximetry: Good Study (icon only)		Notification	After exiting therapy, the therapy device will display the Good Oximetry pop-up screen if the oximetry sensor maintained a good connection for at least 4 consecutive hours within a 24 hour window with breaks in therapy no greater than 1 hour each.	Press the control dial to acknowledge and clear the message.
SD Card Error: Remove and Reinsert		Notification	SD card error detected. Device cannot read the SD card. A problem may exist with the SD card or it was ejected during a writing activity, or it was inserted incorrectly.	Remove SD card and reinsert. If alert continues to occur, replace with another card or contact your home care service provider.

Alert	Icon	Priority	Description	User action
SD Card Full.		Notification	SD card is full.	Remove SD card and contact your home care service provider for a new SD card.
Patient Message		Notification	Message from your provider.	Press the control dial to acknowledge and clear the message.
Change Rejected		Alert	A prescription or settings change was rejected. Change missing or incorrect.	Contact your home care service provider.
Humidification Error. Contact support if the problem persists.		Status	Humidifier error (only when humidifier is present) Humidifier heater plate error or humidifier not properly connected to therapy device.	Turn off device and disconnect from power. Detach the humidifier, visually check that electrical contacts are clear, then reconnect humidifier and power cord. If alert continues, contact your home care service provider.
Heated Tube Error. Contact support if the problem persists.		Status	Heated tube error (only when heated tube is present). Heated tube may be overheated or damaged.	Turn off device. Detach heated tube from humidifier, make sure that tube is not covered or obstructed, and then reattach to humidifier. If alert continues, contact your home care service provider.
The attached power supply does not support humidification.		Alert	Indicates that the attached power supply is not capable of supporting humidification or heated tube.	Contact your home care service provider to obtain a compatible Philips Respironics power supply. Or, operate therapy device without humidifier.

Alert	Icon	Priority	Description	User action
Check Power		Notification	Indicates an incompatible power supply is attached. Incompatible power supply, or power cord is not fully inserted into device's power inlet.	Confirm power cord is fully inserted into device's power inlet. Confirm a compatible Philips Respironics power supply is attached. Switch to compatible power supply if needed.
Busy		Status	Displayed when the device is temporarily inaccessible due to data communication.	No action needed.
Three Night Summary	n/a	Status	Displays last 3 nights of hourly use.	Press control dial to acknowledge and clear the screen. Otherwise message times out after 30 seconds.
Check Mask Fit	n/a	Status	Displayed when Check Mask Fit function is enabled from Patient Menu.	This alert can be cleared by pressing the control dial. Otherwise, it will time out after 60 seconds.
Loading Language and Rebooting		Status	Displayed when a new language is selected from the menu.	No action needed. Times out when complete.

## 3.10 Troubleshooting

Your device is equipped with a self-diagnostic tool called **Performance Check**. This tool can evaluate your device for certain errors. It also allows you to share key device settings with your Provider. Use Performance Check when directed by your provider.

The table below lists some of the problems you may experience with your device and possible solutions to those problems.

Problem	Why it happened	What to do
Nothing happens when you apply power to the device. The backlights on the buttons do not light.	There's no power at the outlet or the device is unplugged.	<p>If you are using AC power, check the outlet and verify that the device is properly plugged in. Make sure there is power available at the outlet. Make sure the AC power cord is connected correctly to the power supply and the power supply cord is securely connected to the device's power inlet. If the problem continues to occur, contact your home care provider. Return both the device and power supply to your provider, so they can determine if the problem is with the device or power supply.</p> <p>If you are using DC power, make sure your DC power cord and battery adaptor cable connections are secure. Check your battery. It may need recharged or replaced. If the problem persists, check the DC cord's fuse following the instructions supplied with your DC cord. The fuse may need to be replaced. If the problem still occurs, contact your home care service provider.</p>
The airflow does not turn on.	There may be a problem with the blower.	Make sure the device is powered correctly. Make sure the Home screen appears on the user interface. Press the Therapy button on top of the device to start airflow. If the airflow does not turn on, there may be a problem with your device. Contact your home care service provider for assistance.
The device's display is erratic.	The device has been dropped or mishandled, or the device is in an area with high Electromagnetic Interference (EMI) emissions.	Unplug the device. Reapply power to the device. If the problem continues, relocate the device to an area with lower EMI emissions (away from electronic equipment such as cellular phones, cordless phones, computers, TVs, electronic games, hair dryers, etc.). If the problem still occurs, contact your home care service provider for assistance.

Problem	Why it happened	What to do
<p>The Ramp feature does not work when you press the Ramp button.</p>	<p>Your home care provider did not prescribe Ramp for you, or your therapy pressure is already set to the minimum setting</p>	<p>If Ramp has not been prescribed for you, discuss this feature with your home care provider to see if they will change your prescription. If your provider has enabled Ramp, but the feature still does not work, check the current pressure setting on the Therapy screen. If the therapy pressure is set to the minimum setting (4.0 cm H<sub>2</sub>O), or the Ramp starting pressure is the same as the therapy pressure, the Ramp feature will not work. Make sure that the ramp time setting is at least 5 minutes.</p>
<p>The airflow is much warmer than usual.</p>	<p>The air filters may be dirty. The device may be operating in direct sunlight or near a heater.</p>	<p>Clean or replace the air filters. The temperature of the air may vary somewhat based on your room temperature. Make sure that the device is properly ventilated. Keep the device away from bedding or curtains that could block the flow of air around the device. Make sure the device is away from direct sunlight and heating equipment. If using the humidifier with the device, check the humidifier settings and lower the setting, if possible. Make sure there is water in the humidifier water tank. Refer to the humidifier instructions to make sure the humidifier is working properly. If the problem continues, contact your home care service provider.</p>
<p>The airflow pressure feels too high or too low.</p>	<p>The Tubing type setting may be incorrect.</p>	<p>Make sure the Tubing type setting (22 or 15) matches the tubing that you are using (Philips Respironics 22 or 15 mm tubing). If the Tubing type setting has been changed, contact your home care service provider. If you are using the heated tubing, this setting will be 15H and cannot be changed.</p>
<p>Tube Temperature is turned on but heated tubing is not warm.</p>	<p>Incorrect power supply is being used.</p>	<p>Make sure the 80W power supply is being used or a compatible battery or DC cable is being used.</p>

Problem	Why it happened	What to do
I'm having difficulty adjusting the heated humidifier setting or the heated tube temperature setting.	The blower is not turned on, or the humidifier or heated tube is not fully connected.	The humidifier setting and tube temperature settings can only be adjusted from the Therapy ON display screen. Confirm that the blower is turned on, and that the settings are visible on the right side of the screen, then adjust to desired comfort. If the blower is on but the humidifier settings are not displayed on the Therapy ON screen, then unplug the device. Confirm that the humidifier and/or heated tube electrical contacts are not obstructed or damaged. Then reconnect the humidifier and/or heated tube, and reconnect the device's power supply. Turn the blower on; if the settings are still not visible, contact your provider for assistance.
The water in the water chamber runs out before morning.	Water chamber was not full at start of session. Mask leak is excessively high. The ambient conditions are very dry/cool.	Under most conditions, a full water chamber should last for a typical sleep session. However, many factors impact water consumption, including: the ambient temperature and humidity in your bedroom, your humidifier or heated tube settings, the level of mask leak, and the duration of your sleep session. First, make sure that the water chamber is filled to the maximum fill line at the start of your sleep session. Check that your mask is fitted properly, and adjust as needed to reduce mask leak to normal levels. You may use the Check Mask Fit function to evaluate your mask fit. Also, confirm that the device, humidifier, humidifier seals, and tube are connected properly and not leaking. You may also choose to lower your humidifier and/or heated tube settings or change the humidification mode from Fixed to Adaptive humidification mode to increase the time that your humidifier water will last.
I hear a leak or whistling sound coming from my therapy device or humidifier (not related to mask leak).	The therapy device air inlet may be obstructed. The humidifier or tube is not fully connected. The humidifier seals are not fully seated or are missing.	Check therapy device air inlet is not obstructed, and filters are free of debris and properly inserted. Confirm that the device, humidifier, and tube are connected properly and not leaking. Confirm that the humidifier lid seal and dry box seal are present and properly seated; if needed, gently press around the perimeter of the seals to reseal them.

Problem	Why it happened	What to do
<p>I accidentally spilled water into my humidifier basin.</p>	<p>The water chamber has been filled beyond the maximum fill line.</p>	<p>A small amount of water spilled in the basin of the humidifier will not harm your device. A small spill in the humidifier will evaporate under normal humidifier use. However, too much water in the humidifier basin could spill over the humidifier lid hinge and might damage your furniture.</p> <p>Disconnect power from the device. Remove the water chamber, pour out any excess water until the water level is at or below the maximum fill line and set the chamber aside. Separate the humidifier from the therapy device, and pour out the spilled water. Once the heater plate has cooled, wipe the inside of the humidifier with a paper towel or soft cloth. If needed, dry the underside of the humidifier and confirm that your table top is dry. Reconnect the humidifier and power supply, and reinstall the water chamber.</p>

## 4. Accessories

There are several optional accessories available for your DreamStation BiPAP autoSV device. Contact your home care service provider for additional information on the available accessories. When using optional accessories, always follow the instructions enclosed with the accessories.

### 4.1 Humidifier

You can use the heated humidifier and the heated tube with your device. They are available from your home care provider. A humidifier may reduce nasal dryness and irritation by adding moisture to the airflow.

#### Warning

**For safe operation, the humidifier must always be positioned below the breathing circuit connection at the mask. The humidifier must be level for proper operation.**

#### Note

Refer to the humidifier's instructions for complete setup information.

### 4.2 SD card

The DreamStation BiPAP autoSV device comes with an SD card inserted in the SD card slot on the side of the device. The SD card records information for the home care provider. Your home care provider may ask you to periodically remove the SD card and send it to them for evaluation.

### 4.3 Cellular modem

The DreamStation Cellular Modem is designed for use with select Philips Respironics therapy devices. Once installed, it automatically transfers data between the therapy device and Philips Respironics proprietary compliance software. The cellular modem is able to receive oximetry data and transfer it to the therapy device.

### 4.4 Wi-Fi accessory

Wi-Fi accessory is designed for use with select Philips Respironics therapy devices. Once installed and connected to a local Wi-Fi network it can transfer data between the therapy device and Philips Respironics proprietary compliance software. If available on your model, the accessory is able to receive oximetry data and transfer it to the therapy device.



## 4.5 Link module

The Link Module is able to receive oximetry data and transfer it to the therapy device for home use or in a laboratory setting. For use in a laboratory setting, the Link Module also includes an RS-232 (or “DB9”) port to allow remote control of the DreamStation BiPAP autoSV device by a personal computer.

### Notes

Please consult the instructions that accompany the Link Module for installation and removal.

There are no SpO<sub>2</sub> alarms available.

Dispose of the module following the same disposal instructions for your therapy device.

### Warnings

**If you notice any unexplained changes in the performance of this device, if it has been dropped or mishandled, if water is spilled into the enclosure, or if the enclosure is broken, discontinue use. Contact your home care provider.**

**Repairs and adjustments must be performed by Philips Respironics-authorized service personnel only. Unauthorized service could cause injury, invalidate the warranty, or result in costly damage.**

**Do not use any accessories, detachable parts, and materials not recommended by Philips Respironics. Incompatible parts or accessories can result in degraded performance.**

## 4.6 Oximeter

The DreamStation oximetry system, when part of the DreamStation BiPAP autoSV device, measures and displays %SpO<sub>2</sub> and heart rate in adult patients.

### Warning

**Use only Philips Respironics recommended SpO<sub>2</sub> cables and pulse oximeter sensors. Use of incompatible sensors can result in inaccurate pulse oximeter performance.**

## 4.7 Philips Respironics proprietary compliance software

You can use the Philips Respironics proprietary compliance software to download prescription data from the SD card to a computer. It can be used by clinicians to receive and report stored data from the SD card.

## 4.8 Roll stand

There is a roll stand available for use with your BiPAP autoSV device. Please see the instructions included with your roll stand for more information.

## 4.9 Supplemental oxygen

Oxygen may be added anywhere in the patient circuit provided that a pressure valve is used. Please note the warnings in Chapter 1 when using oxygen with the device.

## 4.10 DC power cord

A Philips Respironics DC power cord can be used to operate this device in a stationary recreational vehicle, boat, or motor home. In addition, a Philips Respironics DC battery adapter cable, when used with a DC power cord, allows the device to be operated from a 12 VDC free-standing battery.

### Cautions

**Always ensure that the DC power cord securely fits into your therapy device prior to use. Contact your home care provider or Philips Respironics to determine if you have the appropriate DC cord for your specific therapy device.**

**When DC power is obtained from a vehicle battery, the device should not be used while the vehicle's engine is running. Damage to the device may occur.**

**Only use a Philips Respironics DC Power Cord and Battery Adapter Cable. Use of any other system may cause damage to the device.**

Refer to the instructions supplied with the DC power cord and adapter cable for information on how to operate the device using DC power.

## 4.11 Carrying case and airline travel

The device is suitable for use on airlines when it is operating from an AC or DC power source.

### Note

The device is not suitable for airline use with any modems or humidifiers installed.

For your convenience at security stations, there is a note on the bottom of the device stating that it is medical equipment. It may be helpful to bring this manual along with you to help security personnel understand the device.

When traveling, the carrying case is for carry-on luggage only. The carrying case will not protect the system if it is put through checked baggage. If traveling with the optional humidifier, do not travel with water in the water tank.

If you are traveling to a country with a line voltage different than the one you are currently using, a different power cord or an international plug adaptor may be required to make your power cord compatible with the power outlets of the country to which you are traveling. Contact your home care or service provider for additional information.

# 5. Care, cleaning, and disinfection

This chapter details how to care for the filters, clean the device, humidifier, and tubing, and disinfect the device and humidifier.

## 5.1 Caring for the filters

Under normal usage, you should rinse the reusable blue pollen filter at least once every two weeks and replace it with a new one every six months.

The disposable light-blue ultra-fine filter should be replaced after 30 nights of use or sooner if it appears dirty or damaged. DO NOT rinse the ultra-fine filter.

### Caution

**Clogged inlet filters may cause high operating temperatures that may affect device performance. Regularly examine the inlet filters as needed for integrity and to check for accumulated debris.**

Follow these steps to rinse the reusable filter:

1. If the device is operating, stop the airflow. Disconnect the device from the power source.
2. Remove the filter(s) from the device. Refer to the **Installing and replacing the air filters** section of this manual.
3. Take the reusable filter to a sink, turn it upside down, and run warm tap water through the white middle portion of the filter to rinse away any debris.
4. Shake the filter to remove as much water as possible.
5. Allow the filter to air dry completely before reinstalling it. If the filter is damaged, replace it.
6. Reinstall the filters. Refer to the **Installing and replacing the air filters** section of this manual.

### Caution

**Never install a wet filter into the device. You must ensure sufficient drying time for the filter.**

### Notes

Only Philips Respironics-supplied filters should be used as replacement filters.

Replace the disposable, ultra-fine filter if it is damaged or has accumulated debris.

## 5.2 Home cleaning: device and humidifier

### Warning

To avoid electrical shock, always unplug the power cord from the wall outlet before cleaning the device. DO NOT immerse the device in any fluids.

1. Unplug the device, and wipe the outside of the device with a cloth slightly dampened with water and a mild liquid dishwashing detergent. Use a mixture of 1 teaspoon (5 milliliters) dishwashing detergent/1 gallon (3.8 liters) of water. Let the device air dry completely before plugging in the power cord.
2. Inspect the device and all circuit parts for damage after cleaning. Replace any damaged parts.

## 5.3 Home cleaning: tubing

Clean the flexible tubing before first use and once per week. Disconnect the flexible tubing from the device. For the 15 or 22 mm flexible tubing, gently wash the tubing in a solution of warm water and a mild liquid dishwashing detergent. Rinse thoroughly. Air dry. Inspect the tubing for damage or wear. Discard and replace if necessary.

### Note

Refer to the DreamStation humidifier manual for the instructions on how to clean the heated tube.

## 5.4 Hospital and institution cleaning: device and humidifier exterior

### Warning

To avoid electrical shock, always unplug the power cord from the wall outlet before cleaning the device. DO NOT immerse the device in any fluids.

If using the device and humidifier on multiple users, the device and humidifier exterior should be cleaned between patient use and as needed by performing the following steps:

1. Turn the device off and disconnect from the power source before cleaning.
2. Remove the blue pollen filter and light-blue disposable ultra-fine filter (if using).

### Warning

If you are using the device on multiple users, discard and replace the bacteria filter each time the device is used on a different person.

3. Clean the device and humidifier exterior using a mild liquid dishwashing detergent. Use a mixture of 1 teaspoon (5 milliliters) dishwashing detergent/1 gallon (3.8 liters) of water.
4. Allow the device and humidifier to air dry.

## 5.5 Hospital and institution disinfection: device and humidifier exterior

### Cautions

Only the hospital and institution cleaning and disinfection procedure listed in this guide is recommended by Respironics. Use of other cleaning and disinfecting processes, not specified by Respironics, may affect the performance of the product.

Follow all instructions from the manufacturer of the disinfectant product. Any deviation from these instructions, the manufacturer's instructions, or agents not listed in this guide may impact the performance of the product. Review all applicable instructions for additional warnings and cautions.

If using the device and humidifier on multiple users, the device and humidifier exterior should be disinfected between patient use as follows:

1. Clean the device and humidifier as indicated in **Hospital and institution cleaning: device and humidifier exterior**.
2. Use one of the following to disinfect all exterior surfaces of the device and humidifier, including the filter and accessory access doors.
  - DisCide Ultra Towelettes
  - Cloth with chlorine bleach (8% sodium hypochlorite), 1 to 10 part reduction with water.
3. Pay close attention to all corners and crevices.
4. Open the humidifier lid and disinfect the latch area.
5. Allow the device and humidifier to air dry completely before plugging in the power cord and turning the device on.

## 5.6 Service

The device does not require routine servicing or preventative maintenance other than inspection for normal wear or damage and device cleaning.

### Warning

**If you notice any unexplained changes in the performance of this device, if it is making unusual or harsh sounds, if it has been dropped or mishandled, if water is spilled into the enclosure, or if the enclosure is broken, disconnect the power cord and discontinue use. Contact your home care provider.**

# 6. Specifications, disposal, and EMC

## 6.1 Specifications

### 6.1.1 Environmental

Operating Temperature	5° to 35° C (41° to 95° F)
Storage Temperature	-20° to 60° C (-4° to 140° F)
Relative Humidity (operating & storage)	15 to 95% (non-condensing)
Atmospheric Pressure:	101 to 77 kPa (0 - 2286 m / 0 - 7500 ft)

### 6.1.2 Physical

Dimensions	15.7 x 19.3 x 8.4 cm (6.2" L x 7.6" W x 3.3" H)
Weight (Device with power supply)	Approximately 1.28 kg (2.83 lbs)

### 6.1.3 Service life

The expected service life of the DreamStation therapy device and Link Module is 5 years.

### 6.1.4 Standards compliance

This device is designed to conform to the following standards:

- IEC 60601-1 General Requirements for Basic Safety and Essential Performance of Medical Electrical Equipment
- IEC 60601-1-8: Medical Electrical Equipment – Part 1-8: General Requirements for Basic Safety and Essential Performance – Collateral standard: General Requirements, tests and guidance for alarm systems in medical electrical equipment and medical electrical systems
- IEC 60601-1-11: Medical Electrical Equipment – Part 1-11: General Requirements for Basic Safety and Essential Performance – Collateral standard: Requirements for medical electrical equipment and medical electrical systems used in the home healthcare environment
- ISO 10651-6: Lung Ventilators for Medical Use – Particular Requirements for Basic Safety and Essential Performance, Part 6. Home care ventilatory support devices
- EN 60601-1-2 Electromagnetic Compatibility
- RTCA/DO-160G section 21, category M; Emission of Radio Frequency Energy

The CE0123 mark indicates compliance with the following European Union Directive:

- 93/42/EEC Medical Devices Directive, as amended up to and inclusive of Council Directive 2007/47/EC

The device is also designed and tested to: 2011/65/EU Restriction of the use of certain Hazardous Substances (RoHS) in Electric and Electronic Equipment (EEE)



## 6.1.5 IEC 60601-1 classification

Type of Protection Against Electric Shock	Class II Equipment
Degree of Protection Against Electric Shock	Type BF Applied Part
Degree of Protection against Ingress of Water	Device: Drip Proof, IP22 Link Module: Drip Proof, IP22 80W power supply: Drip Proof, IP22
Mode of Operation	Continuous

## 6.1.6 Electrical

AC Power Consumption (with 80W power supply) Note: Power supply is part of the medical electrical equipment.	100 – 240 VAC, 50/60 Hz, 2.0-1.0 A
DC Power Consumption	12 VDC, 6.67 A
Fuses	There are no user-replaceable fuses.

## 6.1.7 Radio specifications

Operating Frequency Range	2402 - 2480 MHz
Maximum Output Power	<10 dBm
Modulation	GFSK, P/4 DQPSK, 8DQPSK

## 6.1.8 Intake port filters

Pollen Filter	100% Polyester
Ultra-fine Filter	88% Efficient @ 7-10 micron size Blended Synthetic Fiber 95% Efficient @ 0.5-0.7 micron size

## 6.1.9 Sound

Alarm sound level range: 45 dB(A) to 85 dB(A)

## 6.1.10 Declared dual-number noise emissions values (in accordance with ISO 4871)

The A-weighted sound pressure level	Device: 25.8 dB(A) with and uncertainty of 2 dB(A). Device with Humidifier: 27.9 dB(A) with and uncertainty of 2 dB(A).
The A-weighted sound power level	Device: 33.8 dB(A) with an uncertainty of 2 dB(A). Device with Humidifier: 35.9 dB(A) with an uncertainty of 2 dB(A).

### Note

Values determined according to noise test code given in ISO 80601-2-70:2015, using the basic standards ISO 3744 and ISO 4871.

## 6.1.11 Control accuracy

Parameter	Range	Accuracy
IPAP	4 – 30 cmH <sub>2</sub> O	± 2.5 cmH <sub>2</sub> O*
EPAP	4 – 20 cmH <sub>2</sub> O	± 2.5 cmH <sub>2</sub> O*
CPAP	4 – 20 cmH <sub>2</sub> O	± 2.5 cmH <sub>2</sub> O*
Breath rate	4 to 30 BPM	greater of ± 1 BPM or ±10% of setting
Inspiration time	0.5 to 3 seconds	± (10% of setting + 0.1 second)

\*Pressure measured at the patient connection port with or without the integrated heated humidifier (no patient flow).

## 6.1.12 Pressure accuracy

Pressure increments: 4.0 to 30.0 cmH<sub>2</sub>O (in 0.5 cmH<sub>2</sub>O increments)

## 6.1.13 Displayed parameter accuracy

Parameter	Accuracy	Resolution	Range
Estimated Leak Rate	± (5 + 15% of reading) LPM	1 LPM	0 to 200 LPM
Exhaled Tidal Volume	± (25 + 15% of reading) mL	1 mL	0 to 2000 mL
Respiratory Rate	greater of ± 1 BPM or ± 10% of reading	1 BPM	0 to 60 BPM
Exhaled Minute Ventilation	± (1 + 15% of reading) LPM	1 LPM	0 to 99 LPM

## 6.1.14 Spontaneous breathing during power failure conditions

Patient flow (lpm)	Expiratory pressure (cmH <sub>2</sub> O) Passive circuit	Inspiratory pressure (cmH <sub>2</sub> O) Passive circuit
30	<1.8	<2.1
60	<4.9	<5.5

## 6.2 Disposal

Separate collection for electrical and electronic equipment per EC Directive 2012/19/EU. Dispose of this device in accordance with local regulations.

## 6.3 EMC information

Your unit has been designed to meet EMC standards throughout its Service Life without additional maintenance. There is always an opportunity to relocate your DreamStation Therapy Device within an environment that contains other devices with their own unknown EMC behavior. If you believe your unit is affected by locating it closer to another device, simply separate the devices to remove the condition.

### Pressure and Flow Accuracy

If you suspect that the pressure and/or flow rate accuracy is affected by EMC interference remove power and relocate the device to another area. If performance continues to be affected discontinue use and contact your home care provider.

### SpO<sub>2</sub> and Pulse Rate Accuracy

The DreamStation Therapy Device is designed to capture the SpO<sub>2</sub> and Pulse Rate oximetry data within the accuracy specification described in the sensor manufacturer's instructions for use. When 4 hours of successful oximetry data have been achieved the device indicates this to the user by displaying "Oximetry: Good Study". If you suspect that your unit is affected by EMC interference remove power and relocate the device to another area. If performance continues to be affected discontinue use and contact your home care provider.

Guidance and Manufacturer’s Declaration – Electromagnetic Emissions – This device is intended for use in the electromagnetic environment specified below. The user of this device should make sure it is used in such an environment.

EMISSIONS TEST	COMPLIANCE	ELECTROMAGNETIC ENVIRONMENT - GUIDANCE
RF emissions CISPR 11	Group 1	The device uses RF energy only for its internal function. Therefore, its RF emissions are very low and are not likely to cause any interference in nearby electronic equipment.
RF emissions CISPR 11	Class B	The device is suitable for use in all establishments, including domestic establishments and those directly connected to the public low-voltage power supply network.
Harmonic emissions IEC 61000-3-2	Class A	
Voltage fluctuations/Flicker emissions IEC 61000-3-3	Complies	
Emission of Radio Frequency Energy RTCA/DO-160G Section 21	Category M	This device is suitable for use onboard commercial airplanes inside passenger cabin.

Guidance and Manufacturer’s Declaration – Electromagnetic Immunity – This device is intended for use in the electromagnetic environment specified below. The user of this device should make sure it is used in such an environment.

IMMUNITY TEST	IEC 60601 TEST LEVEL	COMPLIANCE LEVEL	ELECTROMAGNETIC ENVIRONMENT - GUIDANCE
Electrostatic Discharge (ESD) IEC 61000-4-2	±8 kV contact ±15 kV air	±8 kV contact ±15 kV air	Floors should be wood, concrete or ceramic tile. If floors are covered with synthetic material, the relative humidity should be at least 30%.
Electrical fast Transient/burst IEC 61000-4-4	±2 kV for power supply lines ±1 kV for input-output lines	±2 kV for supply mains ±1 kV for input/output lines	Mains power quality should be that of a typical home or hospital environment.
Surge IEC 61000-4-5	±1 kV differential mode ±2 kV common mode	±1 kV differential mode ±2 kV for common mode	Mains power quality should be that of a typical home or hospital environment.
Voltage dips, short interruptions and voltage variations on power supply input lines IEC 61000-4-11	<5% $U_T$ (>95% dip in $U_T$ ) for 0.5 cycle at 45 degree increments 70% $U_T$ (30% dip in $U_T$ ) for 0.5 seconds <5% $U_T$ (>95% dip in $U_T$ ) for 5 seconds	<5% $U_T$ (>95% dip in $U_T$ ) for 0.5 cycle at 45 degree increments 70% $U_T$ (30% dip in $U_T$ ) for 0.5 seconds <5% $U_T$ (>95% dip in $U_T$ ) for 5 seconds	Mains power quality should be that of a typical home or hospital environment. If the user of the device requires continued operation during power mains interruptions, it is recommended that the device be powered from an uninterruptible power supply or a battery.
Power frequency (50/60 Hz) magnetic field IEC 61000-4-8	30 A/m	30 A/m	Power frequency magnetic fields should be at levels characteristic of a typical location in a typical hospital or home environment.
NOTE: $U_T$ is the a.c. mains voltage prior to application of the test level.			

Guidance and Manufacturer’s Declaration – Electromagnetic Immunity – This device is intended for use in the electromagnetic environment specified below. The user of this device should make sure it is used in such an environment.

IMMUNITY TEST	IEC 60601 TEST LEVEL	COMPLIANCE LEVEL	ELECTROMAGNETIC ENVIRONMENT - GUIDANCE
Conducted RF IEC 61000-4-6	3 Vrms 150 kHz to 80 MHz	3 Vrms 150 kHz to 80 MHz	Portable and mobile RF communications equipment should be used no closer to any part of the device, including cables, than the recommended 30 cm separation distance.  Interference may occur in the vicinity of equipment marked with the following symbol: 
Radiated RF IEC 61000-4-3	6 Vrms Amateur Radio & ISM Bands between 150 kHz and 80 MHz  10 V/m 80 MHz to 2.7 GHz  Special Telecommunication Bands between 300 MHz and 5.6 GHz	6 Vrms Amateur Radio & ISM Bands between 150 kHz and 80 MHz  10 V/m  Up to 28 V/m	

# Limited warranty

Respironics, Inc. warrants that the system shall be free from defects of workmanship and materials and will perform in accordance with the product specifications for a period of two (2) years from the date of sale by Respironics, Inc. to the dealer. If the product fails to perform in accordance with the product specifications, Respironics, Inc. will repair or replace – at its option – the defective material or part. Respironics, Inc. will pay customary freight charges from Respironics, Inc. to the dealer location only. This warranty does not cover damage caused by accident, misuse, abuse, alteration, water ingress, and other defects not related to material or workmanship. The Respironics, Inc. Service department shall examine any devices returned for service, and Respironics, Inc. reserves the right to charge an evaluation fee for any returned device as to which no problem is found after investigation by Respironics, Inc. Service.

This warranty is non-transferable by unauthorized distributors of Respironics, Inc. products and Respironics, Inc. reserves the right to charge dealers for warranty service of failed product not purchased directly from Respironics, Inc. or authorized distributors.

Respironics, Inc. disclaims all liability for economic loss, loss of profits, overhead, or consequential damages which may be claimed to arise from any sale or use of this product. Some states do not allow the exclusion or limitation of incidental or consequential damages, so the above limitation or exclusion may not apply to you.

This warranty is given in lieu of all other express warranties. In addition, any implied warranties – including any warranty of merchantability or fitness for the particular purpose – are limited to two years. Some states do not allow limitations on how long an implied warranty lasts, so the above limitation may not apply to you. This warranty gives you specific legal rights, and you may also have other rights which vary from state to state.

To exercise your rights under this warranty, contact your local authorized Respironics, Inc. dealer or contact Respironics, Inc. at one of the following addresses:

1001 Murry Ridge Lane  
Murrysville, Pennsylvania 15668-8550  
1-724-387-4000

Deutschland  
Gewerbestrasse 17  
82211 Herrsching, Germany  
+49 8152 93060

**Note: For Australian and New Zealand customers this warranty replaces the warranty contained above.**

1. Respironics, Inc., a Philips Healthcare company warrants that the Products shall be free from defects of workmanship and materials and will perform in accordance with the Product specifications. 2. This warranty is valid for a period of two (2) years from the date of purchase from an authorised Respironics dealer. 3 If the Product is found to contain a defect of workmanship or materials or fails to perform in accordance with the Product specifications during the applicable warranty period, Respironics will repair or replace, at its option, the defective material or part. 4. The customer is responsible for returning the product to an authorised Philips Respironics dealer, and collecting the product from the authorised Philips Respironics dealer after repair or replacement, at its own cost. Philips Respironics is responsible only for the freight cost of transporting the product between the authorised Philips Respironics dealer and Respironics. Respironics reserves the right to charge an evaluation and postage fee for any returned Product as to which no problem is found following investigation. 5. This warranty does not cover damage caused by accident, misuse, abuse, alteration, and other defects not related to materials or workmanship. 6. The warranty provided by Respironics herein is not transferrable by the Buyer in the event of any sale or transfer of Products purchased by the Buyer from an authorised Respironics dealer. 7. To the extent permitted by law, where the Buyer has the benefit of an implied guarantee under the Australian Consumer Law, but the Product is not of a kind ordinarily acquired for personal, domestic or household use or consumption Respironics' liability shall be limited, at the option of Respironics, to the replacement or repair of the Product or the supply of an equivalent Product. 8. To exercise your rights under this warranty, contact your local authorised Philips Respironics dealer. A list of all authorised dealers is available at the following link: <http://www.philips.com.au/healthcare>.

Alternatively, you can make a claim under this warranty by contacting Respironics directly at: Philips Electronics Australia Limited, 65 Epping Road, North Ryde NSW 2113, Australia. Tel: 1300 766 488, Email: [prcontact@philips.com](mailto:prcontact@philips.com). 9. The following statement is provided to a Buyer who is a "consumer" under the Australian Consumer Law: Our goods come with guarantees that cannot be excluded under the Australian Consumer Law. You are entitled to a replacement or refund for a major failure and for compensation for any other reasonably foreseeable loss or damage. You are also entitled to have the good repaired or replaced if the goods fail to be of acceptable quality and the failure does not amount to a major failure. 10. The following statement is provided to a Buyer who is a "consumer" under the Consumer Guarantees Act 1993, New Zealand: Our goods come with guarantees that cannot be excluded under the Consumer Guarantees Act 1993. This guarantee applies in addition to the conditions and guarantees implied by that legislation.

